

**APOLLO**  
S P R A Y

**POWER VS SERIES**

**Turbine Instruction Manual**



# TABLE OF CONTENTS

1	Safety.....	3
2	True HVLP™ Spray Finishing Systems .....	5
2.1	How Your HVLP Turbine System Works.....	5
2.2	How Your Spray Gun Works .....	5
2.3	Preparing To Use Your HVLP Turbine .....	6
2.4	Familiarize Yourself With Your True HVLP™ Turbine Spray Gun .....	6
2.5	Get To Know Your Turbine .....	6
3	Apollo HVLP Turbines .....	7
3.1	Apollo Turbine Models Power-3 VS, Power-4 VS, and Power-5 VS .....	8
4	Know Your Coatings .....	9
4.1	Coating Properties .....	9
4.2	Your Choice of Coatings and Viscosity .....	9
4.3	Technique .....	11
5	Using Pressure Pots With Turbine Systems .....	12
5.1	Testing Air Pressure In Pressure Pot .....	13
5.2	Cleaning Pressure Pot .....	13
6	Record Of Turbine .....	14
7	Record Of Turbine Maintenance .....	14
8	Turbine Maintenance And Cleaning .....	15
8.1	Pre-Filter Maintenance .....	15
8.2	Filter Maintenance .....	16
9	Running Multiple Spray Guns With A Turbine .....	17
10	Model 4500 .....	18
11	Model 4550 .....	19
12	Genuine Apollo Accessories .....	21
13	Warranty .....	24

# 1 Safety

Read all instructions and safety precautions before operating the unit.

## **⚠ DANGER**

Indicates a hazardous situation, which, if not avoided, will result in death or serious injury.

## **⚠ WARNING**

Indicates a hazardous situation, which, if not avoided, could result in death or serious injury.

## **⚠ CAUTION**

Indicates a hazardous situation, which, if not avoided, could result in minor or moderate injury.

## NOTICE

Indicates a situation that could result in damage to the equipment or other property.

## **⚠ WARNING**

Risk of fire or explosion! Solvent and paint fumes can explode or ignite, causing severe injury and property damage.

Paints and solvents containing HALOGENATED HYDROCARBONS can react explosively with aluminum. Always check the product's label before using these materials in the unit.

Hazardous vapors: Paint, solvents, insecticides and other materials may be harmful if inhaled, causing severe nausea, fainting or poisoning.

Make sure the room is well ventilated. Avoid all ignition sources, such as static electricity, sparks, open flames, hot objects, sparks from connecting and disconnecting power cords, and working light switches.

Follow the material and solvent manufacturers' safety precautions and warnings. Do not use liquids with flash points less than 100° F (38° C).

Static electricity can be produced by HVLP spraying. Make sure any electrically conductive object being sprayed is grounded to prevent static sparking. The sprayer is grounded to prevent static sparking. The sprayer is grounded through the electrical cord.

Use a respirator or mask whenever there is a chance that vapors may be inhaled. Read all instructions with the mask to ensure that the mask will provide the necessary protection against the inhalation of harmful vapors.

Do not carry the turbine while spraying.

Keep the turbine at the maximum distance from the spraying area.



**NOTICE**

- Tipping the spray gun causes the spray gun to clog. Dried spray material also clogs the pressure delivery tube and fittings. The spray gun does not function when clogging occurs.
- When not in use, be sure to disconnect the hose and place the spray gun into the Handi-Hold™ Docking Station on the turbine to avoid tipping.

**⚠ DANGER**

**Improper installation of the ground plug can result in the risk of electrical shock. If repair or replacement of the plug or cord is necessary, do not connect the ground wire to either flat blade terminal. The wire with green insulation (with or without a yellow stripe) is the grounding wire.**

1. For any question regarding proper installation of the ground plug, consult a qualified (licensed or certified) electrician.
2. Do not modify the plug provided. If the plug does not fit the outlet, have the proper outlet installed by a qualified electrician.
3. This product is for use on a nominal 110-volt circuit and has a grounding plug that looks like the plug in Figure 2. Make sure that the product is connected to an outlet having the same configuration as the plug. Do not use adapters with this product.
4. If an extension cord is required, use only a three-wire extension cord that has the same configuration as the unit cord, including the (round) ground terminal. Make sure that the extension cord is plugged into a properly grounded receptacle.
5. When using an extension cord, be sure it is in good condition and heavy enough to meet the specifications in the chart below. If an extension cord is needed the following wire sizes must be used.

25' cord (7.62m).....	10, 12, or 14 Gauge
50' cord (15.24m).....	10 or 12 Gauge
100' cord (30.48m).....	10 Gauge

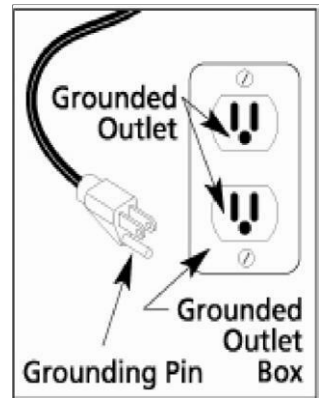

Figure 2

Grounding instructions for all countries using a 2-pronged plug configuration.

**⚠ CAUTION**

**This product must be properly grounded. In the event of an electrical short circuit, grounding reduces the risk of electrical shock by providing an alternate path for the electrical current.**

This product is equipped with a cord that has a ground wire and an appropriate ground plug. Plug the unit into an outlet that is properly installed and grounded in accordance with local codes and ordinances.

Safety Note: Users in countries in continental Europe and Australia and anywhere that offers a two-pronged plug must be aware that this configuration does not provide grounding.

## 2 TrueHVLP™ Spray Finishing Systems

CONGRATULATIONS!! You have just purchased the finest HVLP air turbine system available. You are about to enjoy the great benefits of TrueHVLP™. Our designs are the result of many years of experience in manufacturing HVLP turbine systems, and HVLP spray guns. We have painstakingly worked and consulted with professional spray finishers to bring you this versatile, well-engineered tool.

Whether you are new to spray finishing, you have spray finished before, or are just new to HVLP spraying; there are some basic spray finishing guidelines that will help you to achieve the best results and optimum success from your new equipment. Reading this information carefully and following these simple steps will ensure that you get the best performance and results from your new TrueHVLP™ spray system.

Check the contents of your box. The following are included:

- (1) Power Series Turbine Unit
- (1) TrueHVLP™ Spray Gun
- (1) Air Hose
- (1) Instruction Manual
- (1) Wrench
- (1) Spray Gun Lube
- (1) Cleaning Brush
- (1) Electric Cord
- (2) Quick Coupler (1x Handi-Hold™) (1x Hose Coupler)

### 2.1 How Your HVLP Turbine System Works

Your turbine system has three components: the turbine unit (1), spray gun (2) and air hose (3). The turbine unit, when connected to the correct electrical power supply and with the on/off switch in the “on” position, provides a continuous source of clean, warm, dry, High Volume Low Pressure (HVLP) air. The air hose connects the turbine unit to the spray gun. Air flows through the hose to the nozzle of the specially designed TrueHVLP™ spray gun. Atomization of the coating is achieved when the air mixes with the stream of fluid passing through the tip/nozzle. This low-pressure atomization principle achieves minimum misting (overspray) to the spray environment.



### 2.2 How Your Spray Gun Works

Apollo offers two types of Turbine Spray Guns. The 5000 series and the 7700 series. The 5000 series spray guns are bleeder style. When the turbine blower is turned “on”, air will constantly flow through the air cap. The 7700 series spray guns are non-bleeder style. When the turbine blower is turned “on”, air will only flow through the air cap when the trigger on the spray gun is activated or pulled back. Air also flows through the air feed tube to pressurize the cup and deliver fluid to the tip/nozzle. When the paint flow screw is opened and the trigger pulled back, fluid flows through the tip/nozzle mixing with the air flow

delivered from the air cap and projects a fine atomized mist to your work piece. Spray pattern control will vary depending on the spray gun model. Consult your individual spray gun manual for detailed operation and maintenance of your spray gun.

## 2.3 Preparing To Use Your HVLP Turbine System

Connect the air hose to the turbine. Pull back the spring loaded quick disconnect coupler and insert the male connector on the air hose into the turbine connector. Release the ring. Your air hose will be locked into place. To release the air hose, pull back on the spring-loaded quick coupler ring with your fingers and pull. Connect other end of hose to spray gun using this same procedure. Plug the power cord into an outlet that is properly installed and grounded in accordance with local codes and ordinances.

### NOTICE

**Do not cover or enclose the turbine. It is important to draw cool/ambient air through the unit for optimum performance. Avoid placing the turbine in a warm environment or in direct sunlight. Do not spray in ambient temperatures above 90 degrees. If you want to be able to spray in hotter temperatures we recommend placing a fan in front of your turbine to help it pull in cool air.**

## 2.4 Familiarize Yourself With Your True HVLP™ Turbine Spray Gun

Refer to your Spray Gun Instruction Manual for information, setup, and operation of your model spray gun. You are now ready to spray your coating of choice on your work piece. Good quality results with your TrueHVLP™ spray finishing equipment are a combination of careful preparation of your project, a proper spraying environment, a basic knowledge of the coatings you will be using and how these coatings work with your TrueHVLP™ spray equipment.

### ▲ CAUTION

**Pressure will remain in the spray cup when unit is off. If you pull the trigger back, a stream of fluid will flow. To prevent accidents, turn material flow screw clockwise until it is completely closed. The trigger is now locked in the closed position.**

***Note:** It is not necessary to empty and clean your spray gun when you pause between applications. Be sure, however, to clean your spray gun thoroughly at the end of your work session. Do not leave material in your spray gun overnight. Extra caution must be taken when spraying coatings that have a catalyst or hardener added. These coatings can harden in your spray gun quickly, making cleaning difficult or impossible. Read manufacturer's coating instructions as to how much time you have before catalyst/hardener begins to set up.*

## 2.5 Get To Know Your Turbine

### Handi-Hold™ Spray Gun Docking Station

Every Power Series turbine comes equipped with the Handi-Hold™ Spray Gun Docking Station (A), Apollo's smart innovation. Store, hold or transport your spray gun in a vertical position with no risk of it falling over. Ready to spray when you are. Disconnect hose from spray gun and insert coupler into the Handi-Hold™ Spray Gun Docking Station (A). As shown.



## Hour Use Meter

All Power Series turbines are fitted with an hour use meter (B). Use this meter in conjunction with the Record of Turbine Maintenance at the end of this manual. Using the hour meter will help you maintain your turbine better and keep your system running in good condition.

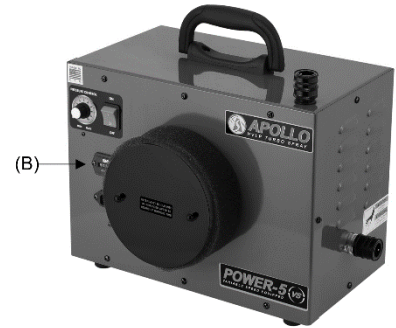

## Variable Speed Motor Control (VS)

The POWER VS Series turbo spray systems integrate a motor speed control to enable you to control your atomizing pressure. To change the pressure, rotate the dial from left to right to increase the pressure and from right to left to decrease the pressure. The graduation marks behind the knob do not indicate any particular pressure achieved. Do not use these marks to replicate pressures as they will not always relate depending on the temperature and length of use. It is always best to set the pressure by doing some spray outs with the material you are going to spray. Adjust the pressure to use the lowest amount of air pressure to achieve the best atomization with that material. Check your spray pattern for even droplet sizes around the edges of the spray out. Once your particles are all the appropriate size you should get good results.



**\*\*WARNING\*\*** The motor will engage between 2 and 3 on the dial and may vary from turbine to turbine.

## 3 Apollo HVLP Turbines

Each TrueHVLP™ Turbine Unit offers the finisher a maximum operating pressure. This pressure is determined by the size and output of the unit you have selected. The maximum available pressure will have a direct bearing upon the viscosity of the fluid that you choose to spray. Atomizing pressure and fluid viscosity directly relate to the efficiency of the equipment operation and the quality of the results that you will achieve.

The available air volume and pressure at the air cap of the spray gun will meet the delivery of fluid coming out of the nozzle to create a fine mist called atomization. This mist travels directly to your work piece where it blends together to form a connected wet film. Achieving a smooth, level surface will depend on the proper relationship between available atomizing pressure, the viscosity of the coating being applied and the properties of the coating and the size of the needle, nozzle and air cap used.

### 3.1 Apollo Turbine Models Power-3 VS, Power-4 VS, and Power-5 VS

#### Model Power-3 VS

**Fan Stages:** 3

**Sealed Pressure:** 7.0 psi (0.48 bar)

**Filter type:** Dual (pre-filter and main filter)

**Watts:** 1508

**Current:** 110 vac - 60 hz or 240 vac - 50 hz

**Weight:** 23 lbs (10.4 kg)

**Height:** 12" (30.48 cm)

**Width:** 8.5" (21.6 cm)

**Length:** 15" (38.1 cm)

All 240-volt units shipped 

All 110-volt units are tested and certified. 



#### Model Power-4 VS

**Fan Stages:** 4

**Sealed Pressure:** 9.0 psi (0.62 bar)

**Filter type:** Dual (pre-filter and main filter)

**Watts:** 1568

**Current:** 110 vac - 60 hz or 240 vac - 50 hz

**Weight:** 24 lbs (10.8 kg)

**Height:** 12" (30.48 cm)

**Width:** 8.5" (21.6 cm)

**Length:** 15" (38.1 cm)

All 240-volt units shipped 

All 110-volt units are tested and certified. 



#### Model Power-5 VS

**Fan Stages:** 5

**Filter type:** Dual (pre-filter and main filter)

**Watts:** 1858

**Current:** 110 vac - 60 hz or 240 vac - 50 hz

**Weight:** 25 lbs/11.3 kg

**Height:** 12" (30.48 cm)

**Width:** 8.5" (21.6 cm)

**Length:** 15" (38.1 cm)

All EU units shipped 

All 110-volt units are tested and certified. 



**NOTE:** All turbine pressures quoted are measured sealed and at the motor outlet. Actual spraying pressures will vary depending on the model and size of the turbine.



## 4 Know Your Coatings

### 4.1 Coating Properties

Coatings are a blend of resins and additives to create a product that will provide a protective and beautifying surface to your work piece. Different resins have different properties. It is important to use the correct coating to achieve a desired result. Manufacturers of coatings can control the resin solids content, production viscosity, sheen, color, flow-out enhancement and other properties. Some products offer ways to adjust the coating properties such as speeding up or slowing down the drying time, adding catalysts to strengthen the molecular bond or adding flattening agents to lower the sheen. Manufacturers will often give some guidelines on how to thin their product for spray application. There are many different types of spray equipment in use. Coatings manufacturers cannot address all of them. It is important for the finisher to understand the spray equipment and to use common sense to arrive at the correct fluid viscosity to produce the best possible results with the selected coating and the equipment being used.

### 4.2 Your Choice of Coatings and Viscosity

Extremely thin, watery or light bodied fluids such as inks, aniline dyes and oil stains can generally be used straight from the can. RTS or Ready to Spray water-based finishing products are formulated to be used straight from the can without thinning with a 3 stage or larger turbine. Most other coating products will need to be thinned anywhere from 10% to 50% depending on the available air pressure of the turbine model and the properties of the coating selected. (see chart below).

**Chart A Turbine Performance**

Turbine Size	Sealed Air Pressure	Coating Types
3 STAGE	7.0 PSI	Low-Medium Viscosity Materials
4 STAGE	9.0 PSI	Low-High Viscosity Materials
5 STAGE	10.0 PSI	Low-High Viscosity Materials

#### Using Latex (Emulsion) Paint

Although your turbine spray system is best suited to spray Class A Finish coatings such as lacquers, enamels, urethanes, varnishes, waterborne and water base etc., you can spray latex (emulsion) house paint if you follow a few simple rules. First, it is generally necessary to thin latex (emulsion) paint. This will vary from as little as 10% to as much as 50% depending on the model turbine you are using and the quality of the paint used. Second, it is necessary to use a larger nozzle and needle set in the spray gun (2.0mm or 2.5mm). It is recommended that a latex (emulsion) paint conditioner like Floetrol®, be added to aid flow-out. These products are sold at local paint stores.

**Chart B Nozzle, Needle And Air Caps For 7500 & 7700 Series Spray Guns**

Tip/Needle Size	Application	Air Cap
0.8MM (.029)	Inks, Dyes, Stains, extremely thin viscosity fluids, Water based finishes	A
1.0MM (.039)	All purpose, thin lacquers, thin enamels, Water based finishes, Automotive, Marine, Airplane finishes	B
1.3MM (.051)	All purpose, thin lacquers, thin enamels, Water based finishes, Automotive, Marine, Airplane finishes	B
1.5MM (.059)	Catalyzed lacquers, Conversion Varnish, Primers, Water-based finishes, Automotive, Marine, Airplane finishes, Varnish, High Viscosity Industrial Coatings, Urethanes, Enamel	B or C
1.8MM (.070)	Catalyzed lacquers, Conversion Varnish, Primers, Automotive, Marine, Airplane finishes, Varnish, High Viscosity Industrial Coatings, Urethanes, Enamel	C
2.0MM (.079)	Thinned Latex (Emulsion) Paint, Multispec, Heavy Primers, Butyrate, Nitrate Dope, C High Viscosity Industrial Coatings	C
2.5MM (.098)	Thinned Latex (Emulsion) Paint, Multispec, Solvent adhesives, Wax based strippers	D

### Chart C Viscosity

Coating	Thin/Reduce
Lacquers	25%-50%
Sanding Sealer	20%-30%
Enamels	20%-40%
Stains	use from can
Acrylic Enamel	50%-60%
Catalyzed Polyurethane	10%-30%
Polyurethane's Varnishes	20%-30%
Waterborne Coatings	00%-10%
Latex/Emulsion Paint	10%- 40%

**Note:** Chart C should be used as a guide to thinning various coatings. Actual reduction will depend upon model turbine used, flow out properties of the coating and the final visual results of the sprayed work piece.

Viscosity Cup Comparison Chart	
ZAHN #2	FORD # 4
16	5
17	8
18	10
19	12
20	15
22	17
24	19
27	21
30	23
34	26
37	29
41	31
49	36
58	41
66	45
74	51
82	56

## 4.3 Technique

Like any skill, practice makes perfect. Never try to rush the spray finishing process. Learn the characteristics of the coating you will be spraying. Build up layers of material (3-4 applications or more if necessary). Sand between coats and allow proper drying time between applications.

Some rules for effective spray finishing:

1. Remember to always keep the distance between the spray gun and the surface the same when moving across your work, (or up and down) called a “pass”. Do not rotate or turn your wrist from side to side.

See Chart E Below

2. Move the spray gun across your work from end to end.
3. Be sure to maintain the same speed of movement. This ensures an even application of coating.
4. At the end of a “pass” always release the trigger. To continue, spray in the opposite direction and overlap your previous coat by 1/3 to 1/2.
5. When finished you should have an even wet coat on your work. If you have dry spots you have overlapped too wide. If you have heavy or wet spots, you have overlapped too much or sprayed too slowly.
6. When spraying a large or pre-assembled piece, start at the top and work down.
7. Try to spray the hard to reach and underneath surfaces first.

Common sense and some forethought will prevent errors. Remember, that a light wet film will generally produce better results than a heavy wet coat. When spraying a vertical surface, it is advisable to apply a thin/light “tack” coat first, followed by a normal light wet coat. This technique will help prevent “runs” and “sags”.

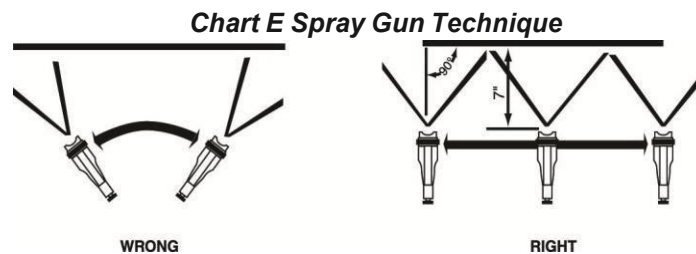

When using your Spray Gun you control five variables:

1. Fluid flow.
2. Distance of the spray gun from your work. 4”-8” (10-20cm) is average. Closer if necessary.
3. Pattern direction (vertical fan, horizontal fan and round).
4. Speed of application.
5. Fan pattern size. 7700 series with Fan Pattern Control Ring. 5000 series move the spray gun closer to or further away from work piece.

*NOTE: Items 1, 2, and 4 directly relate to each other.*

### **Cleaning Your TrueHVLPTM Spray Gun**

Refer to your spray gun manual for cleaning and maintenance of your spray gun model.

## 5 Using Pressure Pots with Turbine Systems

There are many advantages to using pressure pots with a turbine system. Apollo Sprayers have made this very easy with our fluid feed systems, 4500 and 4550. Refer to the accessories section of this manual for more information on these and other products. By removing the paint cup from the spray gun, you immediately reduce the overall weight of the spray gun by ½. You also get a smaller tool to hold in your hand thereby allowing you to more easily access the back of cabinets or other tight spaces where a standard cup gun would not fit.

By using a pressure pot you can spray larger quantities of material without stopping to refill a smaller cup. This can save a lot of time on a long job where you are spraying the same material all the time.

Using a pressure pot with any size turbine system is very easy. All you need is any size pressure pot, a fluid hose and a small air compressor. When using a remote cup or pressure pot, it is necessary to introduce compressed air in order to pressurize the remote pot and move the fluid from the pot to the spray gun tip/nozzle. In general, 5PSI (0.345 Bar) of air pressure is adequate to push most average viscosity fluids to the spray gun nozzle. Higher pressure would only be necessary for heavier viscosity fluids or if you are spraying up a ladder where the fluid has to travel more than 6 feet of elevation.

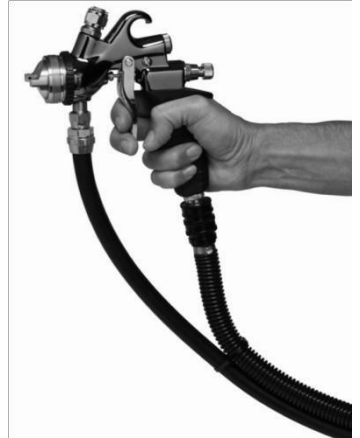

Connect the black fluid hose to the fluid outlet on the top of the pressure pot. Refer to your pressure pot instructions for the specific location of the fluid outlet. Seal the threads with Teflon tape and tighten with a wrench (spanner) to assure no fluid leaks once you pressurize the pot. Next, connect the air line from your compressor to the air inlet. This should be a male quick connect adjacent to the regulator and gauge. If your quick connect is the same style as the one on the pot you can pull back the ring on the female end and insert into the male end, releasing the ring to fasten them together. Connect the other ends of the fluid line and airline to the spray gun and air compressor respectively. Your turbine air hose will connect as normal directly to your spray gun. Refer to your spray gun instruction manual for more specific instructions.

**Part #A4900 - 2.5 gallon (10 liter) deluxe pressure pot.**

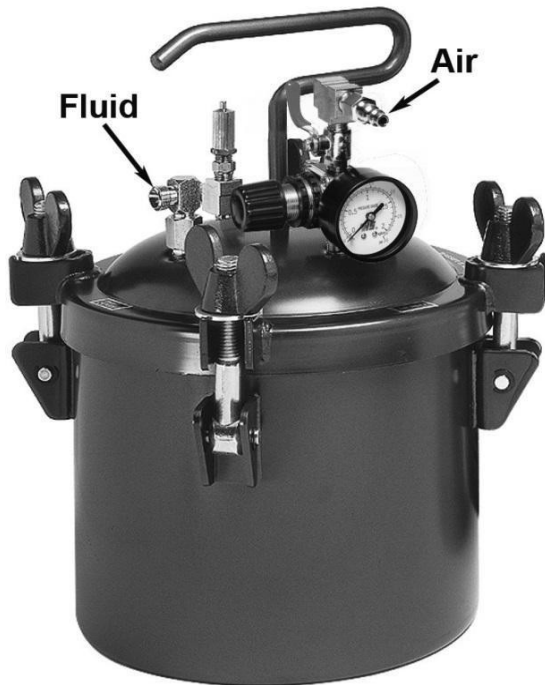

**Part #A4600 - 2-quart (2 liter) pressure pot.**



## 5.1 Testing Air Pressure In Pressure Pot

It is necessary to test the air pressure in the pressure pot to make sure that it is appropriate for the viscosity of material being sprayed and the situation in which it is being sprayed. You don't want the material coming out too quickly so that you get runs and sags, but you also don't want it to come out too slowly so that you are spraying very slowly. To test the air pressure in the pressure pot, follow these simple instructions:

1. DO NOT turn on the turbine at this time.
2. Make sure your air hose and material hoses are connected appropriately to the pressure pot.
3. Turn on your air compressor and wait until you have about 5PSI (0.345 Bar) in the pressure pot. Then, pull the trigger on the spray gun until a stream of fluid flows from the tip/nozzle. NOTE: This may take a few minutes depending on the length of your fluid hose.
4. Adjust the pressure on the pot regulator until the fluid drops off or bends at approximately 2-1/2 " (6.35cm).
5. Your pot air pressure should be correct at this point, however, if the stream bends too short then increase the air pressure. If the stream bends too far, then reduce the air pressure. If you need additional help, please feel free to call our technicians at 1-888-900-4857.

### **▲ CAUTION**

**Depressurize pressure pot using safety valve when equipment will be idle for a while. This will prevent excess fluid from remaining in fluid hose, and prevent a possible accident if the trigger is pulled causing material to stream from the spray gun.**

Always ensure that the remote pot is tightly sealed, and all gaskets are in good shape, to prevent air and fluid leaks. Be sure to flush and clean the fluid hose at the end of a work session. For smaller jobs, insert a one gallon can inside the 2.5-gallon (10 liter) pressure pot. This will help to keep the inside of the pot cleaner.

*NOTE: It may be necessary to provide extra clearance by removing the filter on the bottom of the pickup tube for some paint cans to fit inside the 2.5-gallon (10 liter) pressure pot.*

## 5.2 Cleaning Pressure Pot

Cleaning your pressure pot is important to many years of long faithful service. If you don't clean your pressure pot it will eventually get clogged up with dried material from previous jobs. Make sure you not only clean your pressure pot well, but do it quickly after you are done spraying so as to reduce the amount of time the material has to dry. To clean your pressure pot, follow these simple instructions:

1. Remove the lid and pour your remaining finish back into your can or if you have reduced it, into a different container for storage.
2. Pour solvent or water (depending on the type of finish you have used) into the pressure pot and reseal the lid.
3. Re-pressurize the pressure pot with air.
4. Turn on your turbine and pull the trigger on the spray gun fully open until the material comes out clean.
5. Remove the lid once again and pour out any unused water or solvent.
6. Wipe the inside of the pressure pot, pickup tube and lid with a clean rag.
7. If you use water-based materials, dry the pressure pot.
8. Store in a clean dry place for use next time.

## 6 Record of Turbine Use

Record Of Turbine Use		
Model	Serial #	Date Purchased
Date	Hours Of Use	Total Hours

Turbine Recommended Maintenance: Clean and/or change pre-filters and/or cartridge filters every 50 hours or when necessary. See Accessories Page for appropriate filter replacement for your model.

## 7 Record of Turbine Maintenance

Record Of Turbine Maintenance	
Date	Maintenance Performed

## 8 Turbine Maintenance and Cleaning

### **▲ CAUTION**

**Always unplug your turbine from the main electrical supply before doing any maintenance or repairs.**

After Each Use:

Your Apollo turbine system requires very little maintenance. The turbine motor has sealed bearings that are lubricated for life. The only maintenance that you will need to perform is checking, cleaning and replacing your filters and pre-filters as required. You should check your filters every 10 hours and replace them as necessary. It is very important that your motor has cool, clean air to operate efficiently. If you maintain your filters and prefilters well, you will enjoy many years of long service from your turbine motor.

### **NOTICE**

**Always use genuine Apollo filters and pre-filters. Other types of filters and pre-filters may prevent proper air flow to the motor, resulting in premature motor failure and voiding your warranty.**

### 8.1 Pre-Filter Maintenance

We recommend that you remove your pre-filters after each use. To remove the pre-filters: push your finger between the filter (1) and pre-filter (2) until you can curl it up and pull the pre-filter off, rotating your finger around the pre-filter as you pull. Do not pull hard as you will break the glue line on the pre-filter. Make sure you check both pre-filters as they can get dirty at different intervals. If they appear to be a little dirty or clogged, you can wash them out using a mild soap and warm water. If they are not cleanable you need to install new pre-filters.

To reinstall the pre-filters, hold one in both hands and apply the top first, moving your fingers around the inside as you slide it back over the filter cartridge from top to bottom. NEVER operate your turbine without both filters and pre-filters installed and clean.



## 8.2 Filter Maintenance

Visually check your filters every 10 hours or when you remove your pre-filters for cleaning. Check for accumulated material in the filter element. If you suspect they may be dirty, or if you can see material building up, don't take a chance, remove the filter and hold it up to the light.

To remove your filters, remove two dome nuts (1) and pull filter plate (2) off. Filter plate can hang up on the threads so make sure you pull it off straight. Remove filter (3). If filter is stuck to the side of the case, gently tap them with your hand.



To check your filters, hold them up to a light, similar to your car air intake filter. If you cannot see light through more than 50% of the filter, replace filter element.

### NOTICE

**Filter element may be damaged if more than 50 PSI of air pressure is used to blow out filter element.**

If they appear to be dirty, you can tap them gently on a flat surface to remove any debris. If you have compressed air available, you can also blow them off with air. If you use compressed air to clean your filters, make sure you blow the air from the inside out and never use more than 50 PSI or this will damage the filter element.

To reinstall the filters, reverse the instructions above. Make sure that you line the filter up with the filter plate first, this will help to keep it straight when replacing the dome nuts.



## 9 Running Multiple Spray Guns with A Turbine

All current Apollo Turbine Models have one air hose outlet on the side of the unit and are designed to run one spray gun. These models are equipped with an internal air relief valve to accommodate a non-bleed style spray gun (Apollo Model 7500 or 7700).

It is possible to run a 4 or 5-stage turbine system with two spray guns at the same time by installing an optional “Y” Connector, to the turbine outlet port. It is important to note that if the “Y” Connector is installed and only one spray gun is operated, the 2nd outlet must be capped or closed so that performance to the single spray gun will not be affected. To install a “Y” connector follow these instructions:

1. Unscrew the female quick connect from the air outlet located on the side of your turbine.
2. Screw on the “Y” connector. Make sure the “Y” is sideways so you can easily attach your hoses.
3. Screw the female quick connect you removed from your turbine onto the “Y” connector. If you plan on using two spray guns right away, then make sure you have a 2nd quick connect installed on the other side of the “Y” connector.
4. You are now ready to connect your air hoses and spray guns.

Remember, we do not recommend using the “Y” connector with turbines smaller than 4 or 5-stages. This is due to the power that each model has. The more stages you have the more power you have. When you are running two spray guns on a single turbine you are splitting the air power that turbine has. While you will not divide it equally, you will reduce it considerably, so make sure you do some test areas before you start on your project.



“Y” Connector with single hose and cap



“Y” Connector with two hoses

# 10 Model 4500

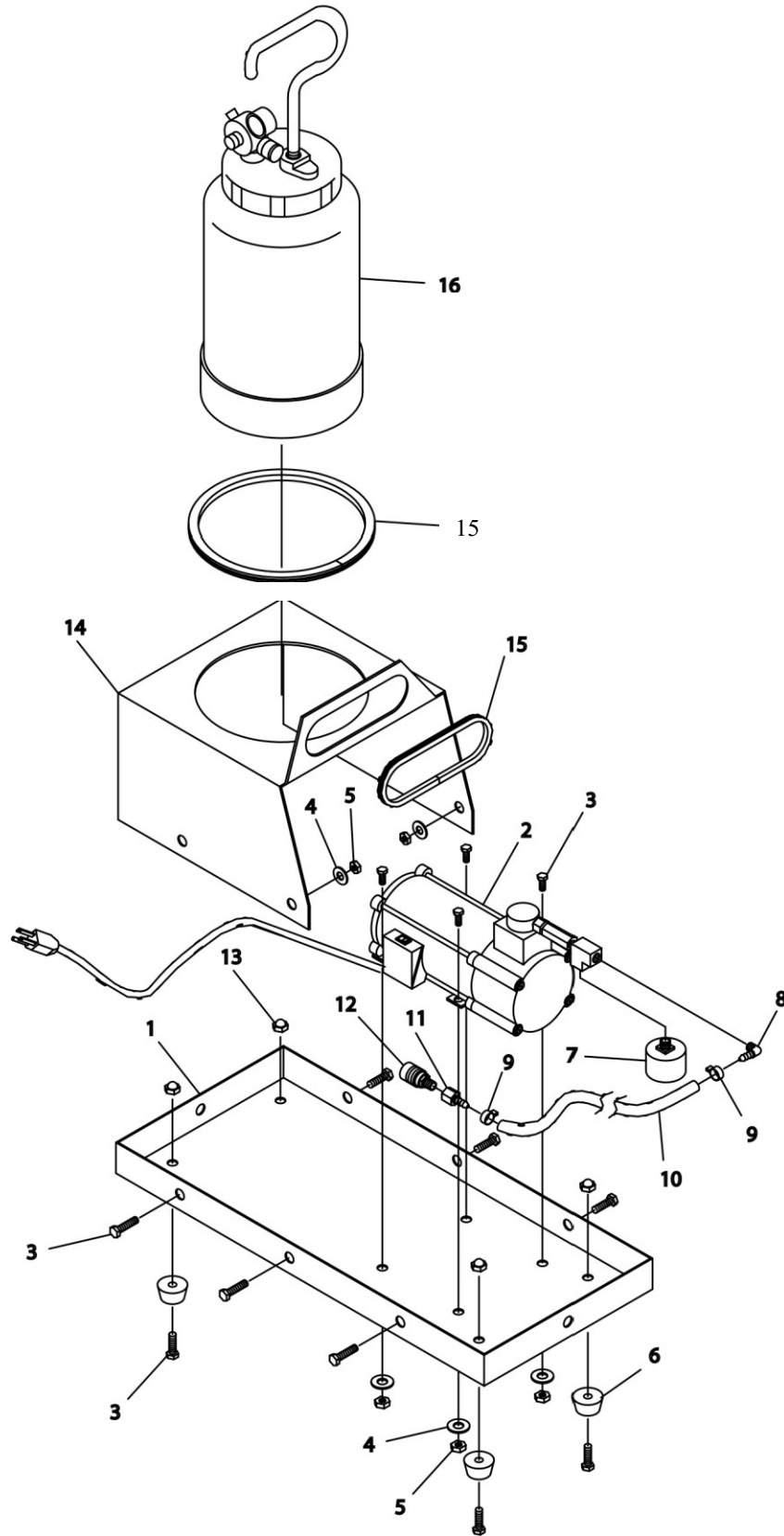

Diagram #	Part #	Description	Quantity
1	A4501	Compressor Deck	1
2	A4198	110v Mini Compressor Unit	1
3	A4320	1/4" X 20 X 1/2" Hex Bolt Plated .5.	12
4	A4300	1/4" SAE F/W Plated Washer	16
5	A4308	1/4" X 20 Hex Nuts Plated	4
6	A9016	Rubber Foot	4
7	A4998	Pressure Regulator	1
8	A4503	1/8" Male NPT X 1/4" Male Hose Barb 90°	1
9	A4033	Air Line Hose Clip S.S.	2
10	A2116	1/4" Air Hose, Per Foot	3
11	A2119	1/4" X 1/4" Female Swivel Barb	1
12	A4026	Quick Connect Female With 1/4" Male Thread	1
13	A4310	1/4" X 20 Cap Nut Plated	8
14	A4502	Pressure Pot Support Bracket	1
15	A4613	Rubber Edge Trim	2
16	A4200	2 Quart Pressure Pot W/Single Regulator	1

# 11 Model 4550

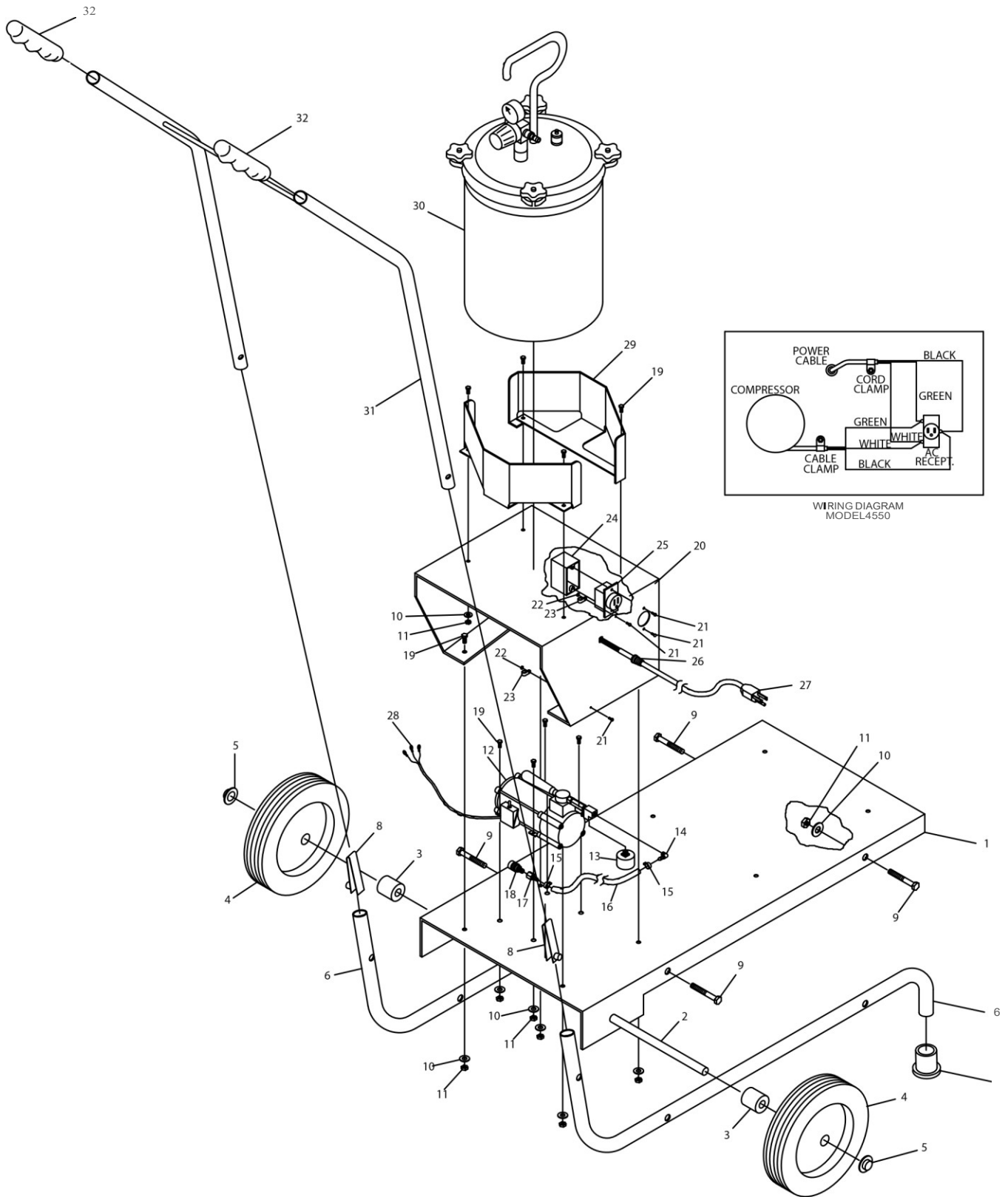

Diagram #	Part #	Description	Quantity
1	A4554	Cart Base Plate Paint Blue	1
2	A4555	Cart Axle (Zinc Plated	1
3	A4556	Wheel Spacer (6061 Alum.)	2
4	A4558	10" X 1 3/4" Wheel	2
5	A4374	1/2" Axle Cap	2
6	A4551	Frame Tube (Chrome)	2
7	A4559	Rubber Tip For Frame Tube	2
8	A4560	Handle Button	2
9	A4364	1/4" X 20 X 1 1/4" Hex Bolt Plated .5.	4
10	A4300	1/4" SAE F/W Plated Washer	20
11	A4308	1/4" X 20 Hex Nuts Plated	20
12	A4198	110v Mini Compressor Unit	1
13	A4998	Pressure Regulator	1
14	A4503	1/8" Male NPT X 1/4" Male Hose Barb 90°	1
15	A4033	Air Hose Clip S.S.	2
16	A2116	1/4" Air Hose, Per Foot	3
17	A2119	1/4" X 1/4" Female Swivel Barb	1
18	A4026	Quick Connect Female With 1/4" Male Thread	1
19	A4320	1/4" X 20 X 1/2" Hex Bolt Plated .5.	16
20	A4553	Pressure Pot Deck	1
21	A4318	6-32 X 1/2" Phillips Pan M/S Plated	4
22	A4307	6-32 Hex M/S Nuts Plated	2
23	A4051	Cable Clamps, Black	2
24	A4557	Outlet Box (Plastic)	1
25	A4197	Outlet 15 amp-125 Volt	1
26	A4053	Flexible Cord Protector	1
27	A4028	8 Foot Power Cord	1
28	A4178	Large Ring Terminal	3
29	A4552	Support Ring For Pressure Pot.	2
30	A4900	2.5 Gallon Pressure Pot	1
31	A4006	Handle (Chrome)	1
32	A4042	Handle Grip	2

## 12 Genuine Apollo Accessories

4500–2 Quart (2 Liter)  
Fluid Feed System #A4500



Designed to be used with Apollo turbine systems:  
Models Power-3 VS, Power-4 VS, Power-5 VS,  
and 900.

Excellent in the shop or on site. Perfect for that  
larger job when a quart (liter) is just not enough  
or when greater spray gun mobility is needed to  
get into a tight corner.

**Includes:** oil-less mini air compressor, 2 quart  
(2 liter) non-stick coated pressure pot with  
stainless steel material tube, 20' (6m) or 30' (9m)  
fluid hose, air blanking screw and 4 wheels  
for easy mobility. Order part #A4500.

4550 –Mobile Cart and  
Fluid Feed System #A4550



Designed to be used with Apollo turbine systems:  
Models Power-3 VS, Power-4 VS, Power-5 VS  
and 900.

Excellent in the shop or on site. Perfect for larger  
jobs when a quart (liter) is just not enough or when  
greater spray gun mobility is needed to get into a  
tight corner. 2.5-gallon (10 liter) pressure pot, non-  
stick coated inside and out, with stainless steel fluid  
parts throughout. Large wheels provide easier  
mobility when going up and down stairs or curbs.

**Includes:** 2.5-gallon (10 liter) deluxe pressure pot,  
oil-less mini air compressor, 20' (6m) or 30' (9m)  
fluid hose, air blanking screw and cart. Order part  
#A4550.

Using genuine Apollo accessories is important to the longevity, ergonomics and portability of your equipment. Other brands of accessories are not designed specifically with your Apollo brand equipment in mind and could cause abnormal functionality. For a complete list of Genuine Apollo parts please visit our website at [www.hvlp.com](http://www.hvlp.com) or call a Customer Service Representative at 888-900-4857.

Handi-Hold™ Spray Gun Docking Station #A5326



Pre-Filters

Replacement Filters

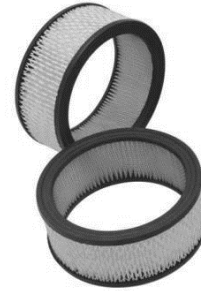

Model Power-3 VS, Power-4 VS, Power-5 VS, 900 # A4096

Model Power-3 VS, Power-4 VS, Power-5 VS, 900 # A4171



Fluid Hoses

- A2113 - 6' (2m) x 1/4" (6mm) fluid hose with couplers
- A2059 - 20' (6m) x 1/4" (6mm) fluid hose with couplers
- A2060 - 40' (12m) x 1/4" (6mm) fluid hose with couplers
- A2114 - 6' (2m) x 3/8" (10mm) fluid hose with couplers
- A2159 - 20' (6m) x 3/8" (10mm) fluid hose with couplers
- A2160 - 40' (12m) x 3/8" (10mm) fluid hose with couplers



Turbine Air Hoses

- A1068 - 24' (7m) x 5/8" (16mm) flex-air hose
- A1069 - 34' (10m) x 5/8" (16mm) flex-air hose
- A1070 - 44' (13m) x 5/8" (16mm) flex-air hose



FS190 – Deluxe Cleaning Kit, Lifetime Warranty

FS 1670 - Filter Stand, Fits 1 & 2 Quart (1 & 2 Liter) Cups.



A5251 - 1 Quart (1 Liter) Cup Assembly



A5269 - 8oz (250ml) Cup Assembly



A5033A – non-Teflon 250cc cup assembly  
A5034A – non-Teflon 600cc cup assembly  
A7536A - non-Teflon 1000cc cup assembly





## 13 Limited Warranty

### 2+1 Year Limited Warranty

All POWER Series turbo paint spray systems that are manufactured by APOLLO SPRAYERS INTERNATIONAL, INC. are WARRANTED by APOLLO SPRAYERS INTERNATIONAL, INC. for a total period of TWO YEARS from the ORIGINAL date of purchase by the ORIGINAL PURCHASER. Proof of purchase to be included and all SHIPPING CHARGES to be pre-paid.

All POWER Series turbo paint spray system warranties can be extended by 1-year by registering your purchase using the online registration page located at [www.hvlp.com/warranty-registration/](http://www.hvlp.com/warranty-registration/) within 30 days of your purchase giving you a total of 3-Years limited warranty.

APOLLO SPRAYERS INTERNATIONAL INC., upon examination of the machine/equipment will replace or repair at their discretion any defects in material or workmanship.

This WARRANTY does NOT include: misuse, damage, neglect, alterations, disassembled equipment or modifications, lack of maintenance, cleaning, water damage to electrical parts, INCORRECT VOLTAGE CONNECTION.

This Warranty is in lieu of all other express warranties, any WARRANTY implied by law, including but not limited to, implied Warranties of merchantability or fitness, is excluded to the maximum extent permitted by law and, if not excludable, is limited to the duration of the express Warranty.

No representative or person is authorized to extend this Warranty or to create for APOLLO SPRAYERS INTERNATIONAL, INC. any other liability in connection with the sale of any APOLLO SPRAYERS product. APOLLO SPRAYERS INTERNATIONAL, INC. shall not be liable for any consequential, incidental or special damages of any kind directly or indirectly resulting from breach of any express or implied warranty.

Some states do allow the exclusion or limitation of incidental or consequential damages or limitations on the length of any Warranty so that the above limitations and exclusions may not apply to you: however, to the maximum extent permitted under applicable law, the only rights and remedies shall be to obtain a replacement for any defective product.

This Warranty gives you specific legal rights and you may also have other rights which vary from State to State.

Apollo Sprayers International, Inc.  
1030 Joshua Way, Vista, CA 92081  
Customer Service: (760) 727-6226  
Fax: (760) 727-9325  
Toll Free Sales: (888) 900-HVLP (4857)  
[www.hvlp.com](http://www.hvlp.com)

 **WARNING:** This product can expose you to chemicals including Chromium, which is known to the State of California to cause cancer and birth defects or other reproductive harm. For more information go to [www.P65Warnings.ca.gov](http://www.P65Warnings.ca.gov).